



Total Lighting Control

One-way Occupancy Sensor for small rooms



DESCRIPTION AND FEATURES

The RSEN-SM is an ultrasonic motion sensor with built-in timing and load control relay driving circuitry. It is designed to control lighting in a room approximately 150 to 500 square feet. It is for use with the GE RTPACK switchpack only, and is not for use with other relays or transformers.

The sensor produces a low intensity, inaudible sound and detects changes in the sound waves caused by motion, such as walking into a room, reaching for a telephone, turning in a chair, etc. The sensor does not respond to audible sound.

When the sensor detects motion, the pre-set time delay period is started and the blue wire is electronically connected to the black wire. This energizes the relay in the RTPACK switchpack which turns on the load. At the end of the pre-set time period, the blue wire is disconnected from the black,

causing the relay to open which turns off the load. The red lead is a +15 VDC supply, the black lead is common and the blue lead is the relay control.

- Full coverage with no gaps for rooms up to 500 square feet
- Minor motion coverage up to 400 square feet
- Not for use in corridors or warehouses
- Separate time delay and sensitivity adjustments
- Manual override should a unit fail (Failed board can be replaced without removing unit or wiring)
- For indoor use

Before proceeding, read the enclosed installation instructions. For GE TLC Service, call: 1-877-584-2685 (USA) or 1-800-661-6619 (Canada)

CAUTION: Do not run the sensor wire in the same conduit as power conductors. Install in accordance with local codes.

INSTALLATION

Basic Installation Steps

1. Locate and mount the sensor.
2. Mount the switchpack.
3. Wire the sensor to the switchpack.
4. Adjust settings and test.

Locating Sensor

Choose the sensor location carefully. The sensor must have a clear view of the area to be controlled. The line of sight must be through air; the sensor will not "see" through glass or high partitions. A mounting height of 12 feet or less is desirable. Avoid pointing directly into hallways. To prevent false activation, do not mount where forced air will blow directly at or by the sensor. For typical placement, refer to the Coverage and Location Diagrams.

Mounting Sensor

Pass the control wires through the threaded mounting post and interlock to the back plate. The sensor mounts to normal ceiling tile through a single $\frac{3}{4}$ " hole. When mounted, the sensor's slotted grills must point along the path where motion is to be detected. **CAUTION: Finger-tighten the nut to avoid stripping the mounting post.**

On hard ceilings an adapter plate is available to allow mounting to a standard fixture ring and junction box. The threaded mounting post may be cut down if it is too long to fit into the junction box.

Mounting Switchpack

The switchpack is generally mounted above the ceiling on the outside of the junction box that contains a hot line, neutral and the existing switch leg from which the lighting is controlled. If additional switchpacks are required, they are mounted on the outside of the boxes containing the appropriate switch legs. In installations where there are no existing switch legs, the switchpack may be mounted on the outside of any standard junction box, with or without an extension ring.

When mounted, the line connections are inside the box and the Class 2 wiring exits via the rear of the switchpack housing. In areas where Class 2 wiring is not permitted, the switchpack can be mounted internally to any standard electrical box.

Sensor Coverage

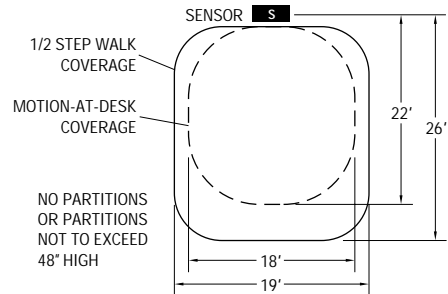

Sensor Location

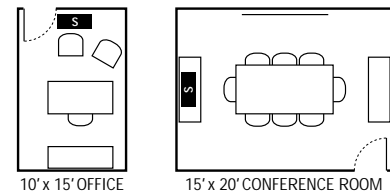

Sensor Mounting

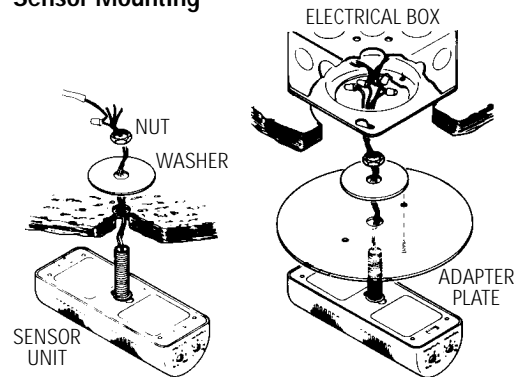

Switchpack Mounting

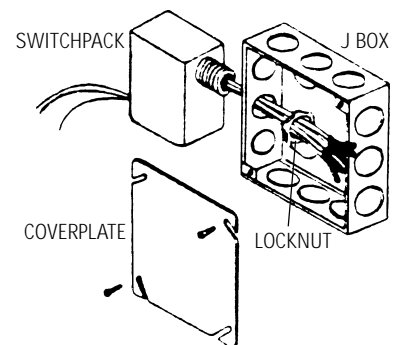

INSTALLATION (CONTINUED)

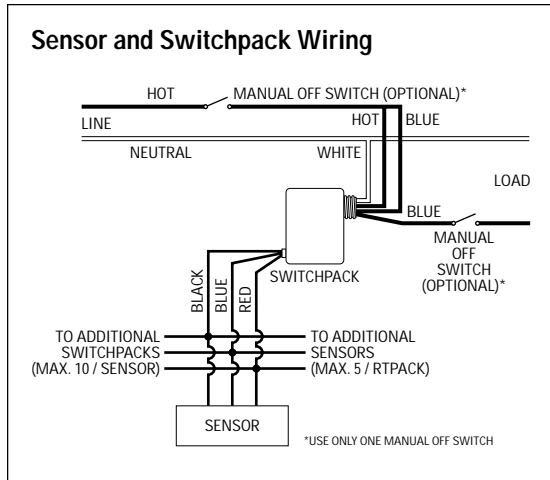

Wiring

CAUTION: The switchpack has a 120 VAC hot lead (black) and a 277 VAC hot lead (orange). Confirm supply voltage before wiring switchpack. Connecting the 277 V to the 120 V lead will damage the switchpack and any connected sensors.

One switchpack may be wired to up to five sensors. One sensor may control up to ten switchpacks. DO NOT exceed these limits.

The switchpack has isolated contacts with ratings of:

| | |
|-----|------------------|
| 15A | 120 VAC Tungsten |
| 20A | 120 VAC Ballast |
| 20A | 277 VAC Ballast |

Each sensor is provided with Teflon-insulated pigtailed. The sensor and switchpack are interconnected using 18 AWG Class 2 wiring per NEC 725. Use UL-recognized Teflon-insulated wire approved for plenum areas per NEC 725-2(b) where required (GE wire # ROSWIRE-4P).

Wire the sensor(s), switchpack(s) and load as shown above.

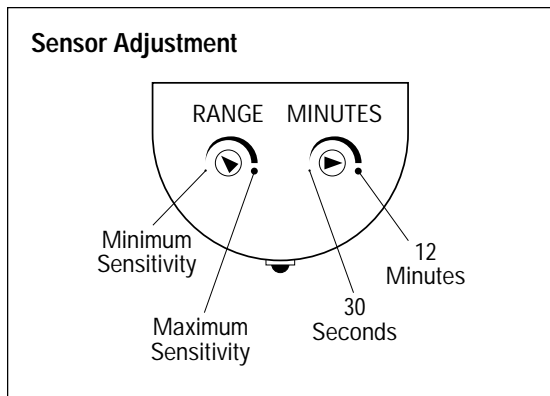

Checkout and Adjustment

Once installed, the sensors must be adjusted for suitable sensitivity and time delay. These adjustments can be made only after the entire system is installed and power is applied to the switchpack and to the lighting circuit. Adjustments should be made with the HVAC system on. See the Sensor Adjustment illustration below left.

1. Using a small screwdriver, set the "Minutes" control to minimum by turning the adjustment completely counter-clockwise. Set the "Range" control to the midpoint.
2. If override switches were installed, check their operation.
3. Stand completely still or leave the room. In approximately 15 seconds, the lights should go out.
4. Walk towards the sensor and the lights will come on. By watching the green LED on the sensor, you can test the area of coverage. The LED comes on only when the sensor is detecting motion. Adjust the Range control to the lowest position that provides adequate motion detection of a person entering the area. Do not set higher than necessary. Test and set Range control for each sensor if more than one was installed.
5. If the green LED blinks when no motion is being made, or does not go off at all, air motion from the HVAC system may be activating the sensor. Reduce the Range control until the LED goes out and stays out when no one is moving. If this setting is too low to respond to normal motion, the sensor may need to be relocated away from the air turbulence.
6. In smaller rooms, the sensor may be activated by people moving by the doorway outside the room. Adjust the Range control toward minimum to prevent this.
7. Set the time delay Minutes control to desired time for lights to remain on after leaving the area. Minimum time is approximately 15 seconds (for testing); maximum is about 30 minutes. Suggested time delay for conference rooms is 6-8 minutes; for classrooms, 8-10 minutes. An eight-minute time delay is approximately 11 o'clock on the Minutes control. People who remain still for very long periods may need a longer time delay. If the lights go out while the room is occupied, increase time slightly until optimum time is reached.

TROUBLESHOOTING

Sensor Cover Removal

1. To remove the sensor's cover, grasp the end of the cover opposite the adjustment controls and pull down gently. The unit will snap open.
2. To replace the cover, position the adjustment controls in the holes in the end and close until cover snaps in place, taking care to align the LED in the center hole of the cover.

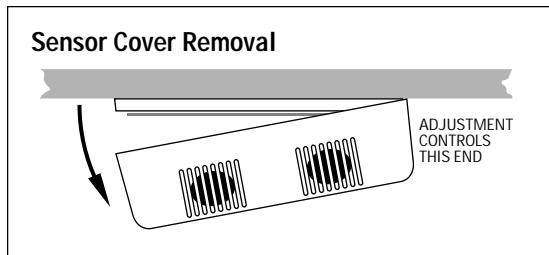

LED Will Not Go On

1. Verify 12-18 VDC across the red and black wires of the sensor.
2. If there is no power at the sensor, check for 12-18 VDC at the switchpack output, and 120 VAC or 277 VAC at the switchpack input. Verify correct primary connections.
3. Recheck all wiring and connections.
4. If the LED still doesn't operate, the sensor is defective; the circuit board should be replaced by unplugging the unit as shown below and snapping out the circuit board.

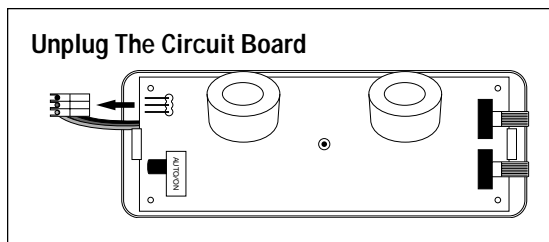

Lights Will Not Turn On

1. Confirm that no other switches or equipment are interrupting or bypassing power to the switchpack or load.
2. Short the blue and black switchpack control leads together to energize the relay.
3. If lights turn on, the sensor is defective, and the circuit board should be replaced.
4. If lights do not turn on, check wiring on the switchpack load side, and check switchpack contacts for continuity. Replace the switchpack if necessary.

Lights Will Not Turn Off

In smaller rooms, the sensor may be activated by people moving in the hallway outside the room. Adjust the Range control toward minimum to prevent this or relocate the sensor. If lights will not turn off after the time period set on the sensor, and the LED has not lit during the time period:

1. Confirm that no other switches or equipment are interrupting or bypassing power to the switchpack or load.
2. Verify that the override switch on all sensor circuit boards is in the AUTO position.
3. Check all connections to the switchpack.
4. Temporarily unplug the sensor circuit board(s).
5. If lights turn off, the sensor is defective, and the circuit board should be replaced.
6. If the lights do not turn off, replace the switchpack.

NOTE: If multiple sensors/switchpacks are installed, check one at a time.

Emergency Manual ON

The sensor has a built-in override switch on the circuit board to turn the load on in the event of sensor failure when the sensor can not be replaced immediately. The switchpack must be operative for this switch to work. If the switchpack is defective, it must be replaced or bypassed to activate the load.

To operate the override switch, remove the sensor cover and move the override switch from the AUTO to the ON position as shown below. All switchpacks connected to the sensor will now be energized. If multiple sensors control the same switchpack(s), activating the override switch on any sensor will activate all switchpacks.

